

Jema Autolifte – Denmark - WE ARE HERE TO SURPRISE!



JA3500T

Lifting capacity: 3500KG

Floor Plate Two Post Lift

Electrical Release

Original Instruction



READ THIS ENTIRE MANUAL
CAREFULLY AND COMPLETELY
BEFORE INSTALLATION
OR OPERATION OF THE LIFT.



INDEX

1. Important safety instructions.....	3~5
1.1 Important notices	
1.2 Qualified personnel	
1.3 Danger notices	
1.4 Condition notices	
1.5 Warning signs	
1.6 Level of sound pressure	
1.7 Training	
2. Overview of the machine.....	5~6
2.1 Product introduction	
2.2 Technical data	
2.3 Construction of the lift	
3. Installation instruction.....	6~12
3.1 Preparation before installation	
3.1.1 Tool and equipments needed	
3.1.2 Parts check	
3.1.3 Space required	
3.2 Precautions during installation	
3.3 Installation	
3.4 Check list after installation	
4. Operation instruction.....	12~15
4.1 Precautions during operation	
4.2 control box panel description	
4.3 Flow chart for operation	
4.4 Operation	
4.5 Emergency lowering when the power is off	
5. Trouble shooting.....	16~16
6. Maintenance.....	17~18
7. Annex.....	18~30
Annex1, Shipping sheet	
Annex2, Overall diagram	
Annex3, Space required	
Annex4, Hydraulic connection	
Annex5, Wiring diagram	
Annex6, Exploded drawing parts	
Annex7, Spare parts list	
Annex8, Sizes and weight requirement for the vehicle and valve board diagram	

1. Important safety instructions

1.1 Important notices

Jema Autolifte will give the user one-year warranty of quality for the machine. If something wrong with the machine within the term of service, we will repair or replace the product according to the user's demand. The manufacturer will not take any responsibility for improper installation and operation, overload running, wrong concrete ground (that cannot meet the requirements in the manual), normal mechanical abrasion and insufficient maintenance. The warranty will be carried out on the basis of the type and serial number of the equipment. Therefore, the users shall provide them to the manufacturer when asking service.

The 2-post lift is suitable for lifting motor vehicles having maximum weight as described, any other use is to be considered improper and irrational and thus highly forbidden. The constructor cannot be held responsibilities for any damage or injuries caused by an improper use or by the non-observance of the following instructions.

Read this guide carefully before using the machine and follow the instructions given by this guide to grant the machine a correct function, efficiency and a long service life.

1.2 Qualified personnel

1.2.1 The lift may only be used by qualified staff, properly trained for the specific use of the machine.

1.2.2 The wiring must comply with local code and a certified electrician for electrical hook up.

1.2.3 Only authorized personnel are allowed in lifting area.

1.3 Danger notices

1.3.1 Do not install the lift on any asphalt surface

1.3.2 Read and understand all safety warning procedures before operating the lift.

1.3.3 The lift, in its standard version, is not designed for outdoor use.

1.3.4 Keep hands and feet away from any moving parts. Keep feet clear of lift when lowering.

1.3.5 The lift may only be used by qualified staff, properly trained for the specific use of the machine.

1.3.6 Do not wear unfit clothes such as large clothes with flounces, tires, etc, which could get caught by moving parts of the machine.

1.3.7 The lift surrounding area must be free from people or objects which could be a danger for lifting operations.

1.3.8 The lift is only designed to lift the entire body of vehicle, having maximum weight not more than the lift capacity.

1.3.9 Always insure the safety devices are engaged before any attempt to work on or near vehicle.

1.3.10 The vehicle must be centered and positioned in a stable correct way with respect to the posts and following the instructions given by manufacturer.

1.3.11 Make sure that the machine and its devices are working correctly, according to the specific instructions for maintenance

1.3.12 Lower the lift to its lowest position when service finishes.

1.3.13 Do not modify the machine without manufacturer's advice.

1.3.14 If the machine is not to be used any more, owners is suggested to removing the power supply connections, emptying the oil tank and disposing the liquids by right way.

1.3.15 If the lift is to be left unused for a long period, proceed as follows:

a. Disconnect the energy source

b. Empty the oil tank

c. Grease the moving parts which might be damaged by dust or drying out

1.4 Condition notices

Generally, this machine will be installed on the following conditions:

1.4.1 Supply voltage: 0.9 - 1.1 nominal supply voltage

1.4.2 Source frequency: 0.99 - 1.01 nominal frequency

1.4.3 Ambient temperature: 5°C - 40°C

1.4.4 Altitude: shall be at altitudes up to 1000m above mean sea level

1.4.5 Relative humidity: not exceed 50% at 40°C

1.4.6 Atmosphere: Free from excessive dust, acid fume, corrosive gases and salt.

1.4.7 Avoid exposing to direct sunlight or heat rays which can change the environmental temp.











1.4.8 Avoid exposing to abnormal vibration.

1.4.9 Electrical equipment shall withstand the effects of transportation and storage temperature within a range of -25°C to 55°C and for short periods not exceeding 24 hours at up to +70°C.

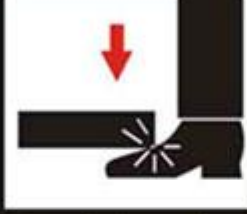
Attention: Dispose the unused oil by a correct way to protect the surround environment.

1.5 Warning signs

All safety warning signs presented on the machine with the purpose to draw the operator's attention from dangerous or unsafe situations. The labels must be kept clean and they have to be replaced if detached or damaged. Read the meaning of the labels carefully and memorize it.

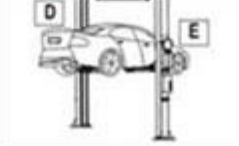
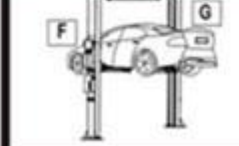
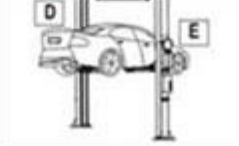
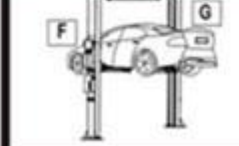
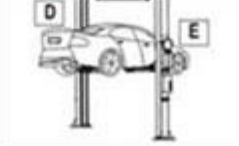
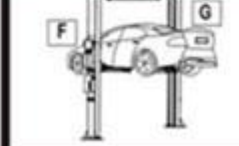
 <p>Remain clear of lift when lowering or lifting vehicle.</p>	 <p>Clear area if vehicle is in danger of falling.</p>	<p>CAUTION</p>  <p>Lift vehicle at the manufacturer's points</p>	<p>CAUTION</p>  <p>Always use safety stands when removing/ installing heavy components</p>																				
 <p>Locate the vehicle with center gravity right between two adapters.</p>	 <p>Keep feet away from adapter while lift lowering.</p>	<p>CAUTION</p>  <p>Use height extension when necessary to ensure good contact.</p>	<p>CAUTION</p>  <p>Auxiliary adapters may reduce load capacity.</p>																				
 <p>Do not override self-closing lift controls</p>	 <p>Do not shake vehicle heavily while on lift.</p>	 <p>Read the manual before installation or operation of the lift</p>	<p>WARNING</p> <ol style="list-style-type: none"> 1. Travelling on the load carrying devices is forbidden. 2. After raising a short distance, checked to ensure that it is correctly and safely positioned. 3. It is forbidden to climb onto the load or load carrying devices when they are raised. 																				
<p>CAUTION</p>  <p>Lift is only allowed to be used by trained operator.</p>	<p>CAUTION</p>  <p>Only authorized personnel allowed in lift area</p>	<p>Arms must support the rated load weight as the following diagram.</p> <table border="1"> <tbody> <tr> <td data-bbox="831 1709 1086 1877">  </td> <td data-bbox="1094 1709 1350 1877">  </td> </tr> <tr> <td data-bbox="831 1888 1086 2029"> <table border="1"> <thead> <tr> <th>Lifting capacity</th> <th>KG distribution</th> </tr> <tr> <td></td> <td>D E</td> </tr> </thead> <tbody> <tr> <td>3500 kg.</td> <td>2.0 - 1.5T (11A.11)</td> </tr> <tr> <td>4200 kg.</td> <td>2.3T - 1.9T (11A.12)</td> </tr> </tbody> </table> </td> <td data-bbox="1094 1888 1350 2029"> <table border="1"> <thead> <tr> <th>Lifting capacity</th> <th>KG distribution</th> </tr> <tr> <td></td> <td>D E</td> </tr> </thead> <tbody> <tr> <td>3500 kg.</td> <td>2.0 - 1.5T (11A.11)</td> </tr> <tr> <td>4200 kg.</td> <td>1.9T - 2.3T (11A.12)</td> </tr> </tbody> </table> </td> </tr> </tbody> </table>				<table border="1"> <thead> <tr> <th>Lifting capacity</th> <th>KG distribution</th> </tr> <tr> <td></td> <td>D E</td> </tr> </thead> <tbody> <tr> <td>3500 kg.</td> <td>2.0 - 1.5T (11A.11)</td> </tr> <tr> <td>4200 kg.</td> <td>2.3T - 1.9T (11A.12)</td> </tr> </tbody> </table>	Lifting capacity	KG distribution		D E	3500 kg.	2.0 - 1.5T (11A.11)	4200 kg.	2.3T - 1.9T (11A.12)	<table border="1"> <thead> <tr> <th>Lifting capacity</th> <th>KG distribution</th> </tr> <tr> <td></td> <td>D E</td> </tr> </thead> <tbody> <tr> <td>3500 kg.</td> <td>2.0 - 1.5T (11A.11)</td> </tr> <tr> <td>4200 kg.</td> <td>1.9T - 2.3T (11A.12)</td> </tr> </tbody> </table>	Lifting capacity	KG distribution		D E	3500 kg.	2.0 - 1.5T (11A.11)	4200 kg.	1.9T - 2.3T (11A.12)
																							
<table border="1"> <thead> <tr> <th>Lifting capacity</th> <th>KG distribution</th> </tr> <tr> <td></td> <td>D E</td> </tr> </thead> <tbody> <tr> <td>3500 kg.</td> <td>2.0 - 1.5T (11A.11)</td> </tr> <tr> <td>4200 kg.</td> <td>2.3T - 1.9T (11A.12)</td> </tr> </tbody> </table>	Lifting capacity	KG distribution		D E	3500 kg.	2.0 - 1.5T (11A.11)	4200 kg.	2.3T - 1.9T (11A.12)	<table border="1"> <thead> <tr> <th>Lifting capacity</th> <th>KG distribution</th> </tr> <tr> <td></td> <td>D E</td> </tr> </thead> <tbody> <tr> <td>3500 kg.</td> <td>2.0 - 1.5T (11A.11)</td> </tr> <tr> <td>4200 kg.</td> <td>1.9T - 2.3T (11A.12)</td> </tr> </tbody> </table>	Lifting capacity	KG distribution		D E	3500 kg.	2.0 - 1.5T (11A.11)	4200 kg.	1.9T - 2.3T (11A.12)						
Lifting capacity	KG distribution																						
	D E																						
3500 kg.	2.0 - 1.5T (11A.11)																						
4200 kg.	2.3T - 1.9T (11A.12)																						
Lifting capacity	KG distribution																						
	D E																						
3500 kg.	2.0 - 1.5T (11A.11)																						
4200 kg.	1.9T - 2.3T (11A.12)																						

1.6 Level of sound pressure

The sound pressure of the car lift does not exceed 75DB. For the sake of your healthy, we suggest you place a noise meter in the operation area.

1.7 Training

Only qualified personnel can operate and use the lift. Contact the manufacturer to provide with trained courses and aid you in becoming familiar with the car lift.

2. Overview of the machine

2.1 Product Introduction

The floor plate lift is composed of posts, carriages, lifting arms, cylinders and power unit, etc.

The lift is operated by an electric motor controlling a hydraulic system, which delivers the hydraulic fluid to cylinders inside the columns for lifting two trolleys. The safety teeth block will bite with safety plate in the posts automatically. Therefore, the lift will not lower when hydraulic system trouble happens.

Safety structure:

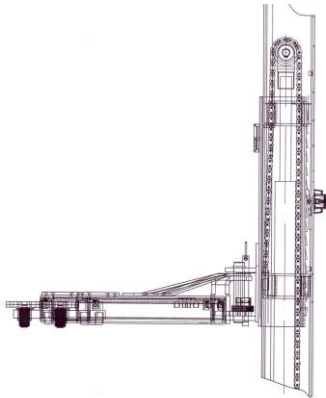

2.2 Technical data

Model	Lifting capacity	Lifting time	Lifting height	Height	Width	Width between posts
JA3500T	3500kg	50 Sec	1900mm	2824mm	3565mm	2780mm

Weight on JA3500T = 700 KG

2.3 Construction of the lift

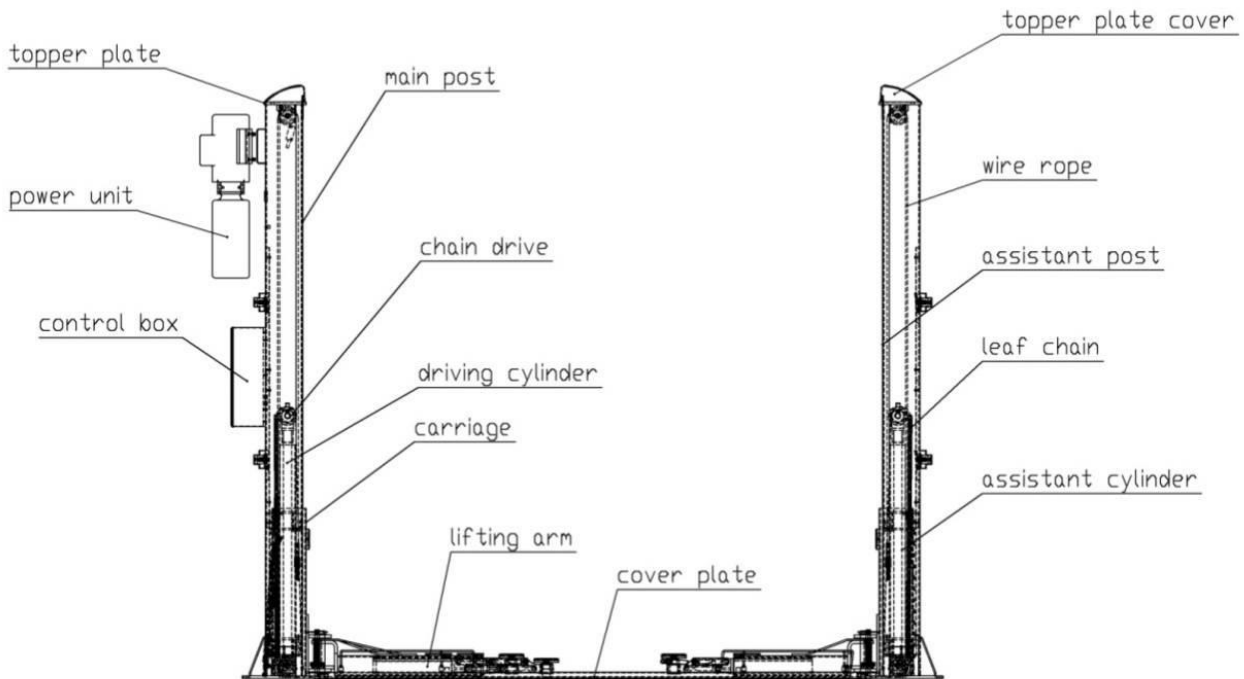

3.1 Preparation before installation

3.1.1 Tools and equipments needed

- ✓ Appropriate lifting equipment
- ✓ AW 32. 46 or other good quality garage hydraulic oil.
- ✓ Rotary Hammer Drill with 3/4" drill bit.
- ✓ Chalk line and tape measure.
- ✓ Sockets and Open wrench set.
- ✓ Hammer 4pounds
- ✓ $\Phi 2$ tape measure

3.1.2 Parts check ---annex 1 (shipping sheet)

Remove the packing material, identify the components and check for shortages as ANNEX 1(shipping sheet), Contact us immediately if shortage discovered. If the buyer still installs the machine upon the shortage, the manufacturer and the dealer will not hold any responsibility and will not solve the problems by free.

3.1.3 Space required

The lift should be located on a relatively level concrete floor, having minimum thickness of 18cm.

The lift should be fixed on a smooth and solid concrete ground with its strength more than 3000psi, tolerance of flatness less than 5mm and minimum thickness of 200mm. In addition, newly built concrete ground must undergo more than 28days' cure and reinforcement.

3.2 Precautions during installation

- 3.2.1 Make sure the two posts are vertical to the floor.
- 3.2.2 Oil hose and wire rope connection should be correct, make sure the joints are tight.
- 3.2.3 All the bolts connection should be tight.
- 3.2.4 Do not place any vehicle when try running the lift.

3.3 Installation

Step one: Remove the packing materials, take out the parts carton and cover plate.

Step two: Remove the packing brackets and bolts holding the two columns together.

Attention: Be careful in this step, in case the posts fall down & the personnel or the parts are damaged.

Step three: Remove the first post and place a supporter under the second post, then remove the bolts.

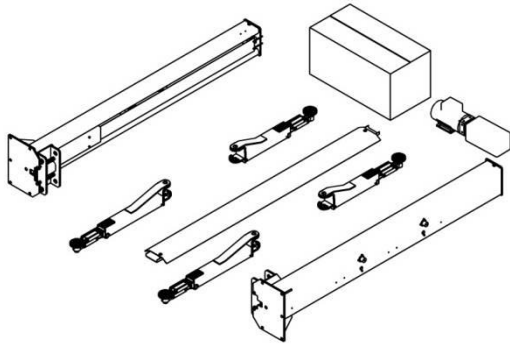

Step four: Decide the installation position of the columns, erect the main and assistant post. Place the bottom plate between the posts to make sure the width is 100% correct (2780MM)

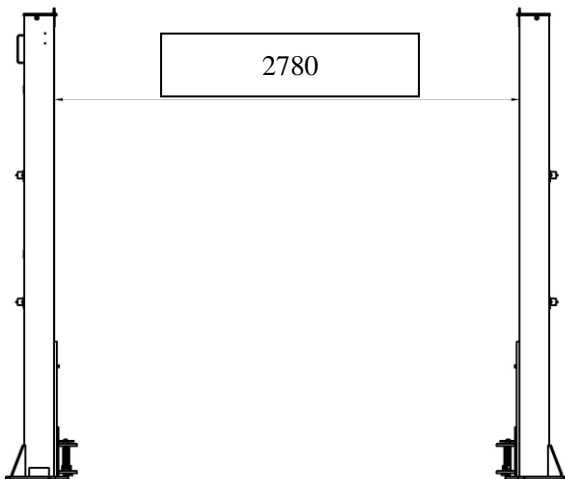

1. Determine which side will be the main post to mount the power unit and the other assistant post.
2. Once the location is selected, place the bottom plate between the posts to make sure the width is correct and make an outline of the posts on the floor at each location.
3. Before proceeding, double check measurements and make certain that the bases of each column are square and aligned with the chalk line.

Step five: erect the posts, main post first and then the assistant post

1. Drill each anchor hole in the concrete using a rotary hammer drill. To assure full holding power, do not ream the hole or allow drill to wobble.
2. After drilling, remove dust thoroughly from each hole and make certain that the column remains aligned with the chalk line during this process.
3. Position the main column at the designated chalk locations and follow the same procedures step 1, 2 to position the assistant column.

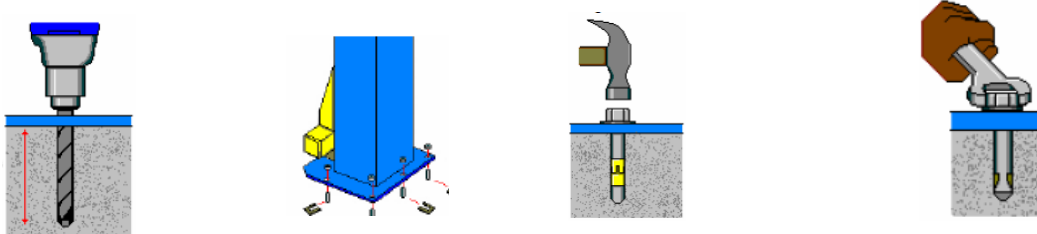

Step six: Install the bottom trough plate

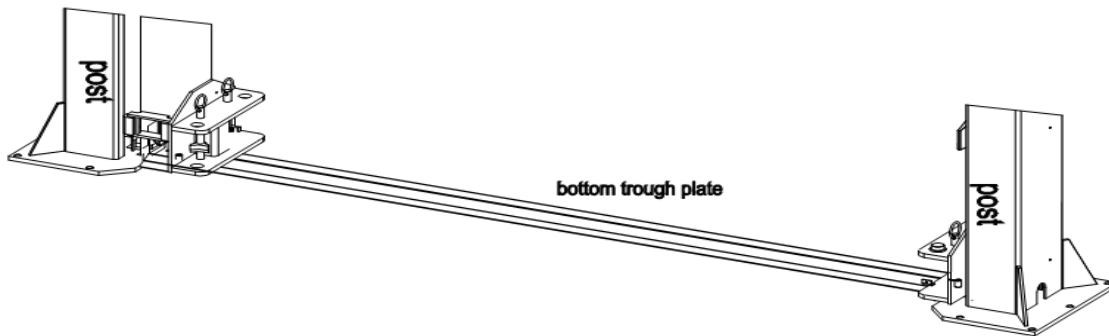

Step seven: connect the wire rope

1. Raise and lock each carriage approximately 800mm high above the ground.
2. Make sure that the safety locks on each column are fully engaged before attempting to route equalizer cables.
3. Carriages must be equal height from the floor before proceeding.
4. With the carriages in equal position from the floor, route the equalizer cables as shown.
5. After the equalizer cables have been routed, adjust each cable so that they are equal tension.
6. Grease the wire rope with butter.(this step must be carried out)

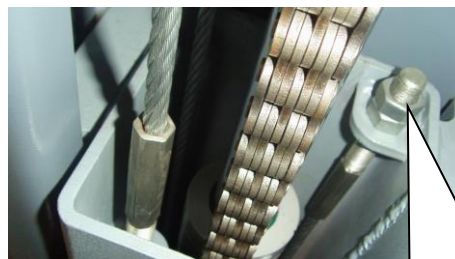
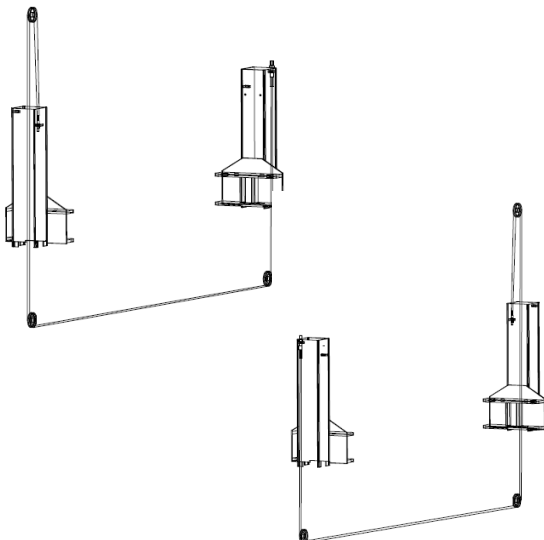

Bolt to adjust the tightness of the wire rope

Step eight: connect the oil hose

Connect the oil hose as the following diagram.

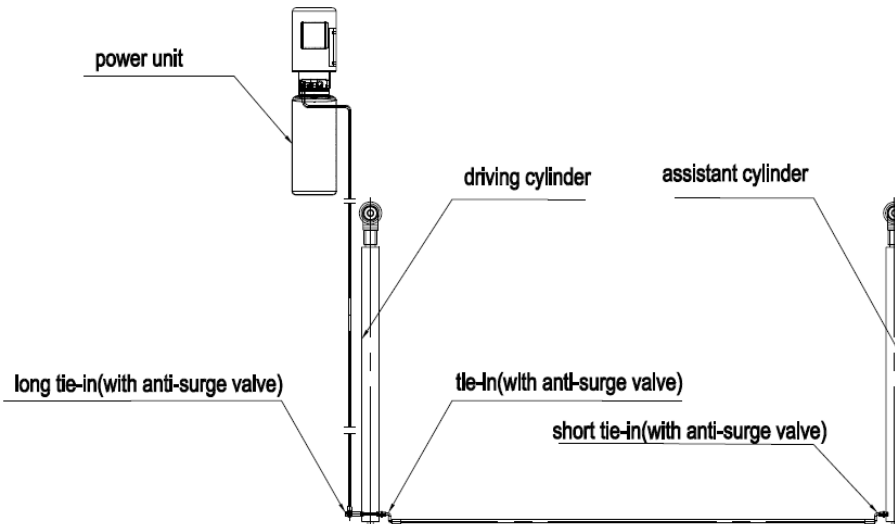

Step nine: Install four safety plates, four electromagnets and the electromagnet covers

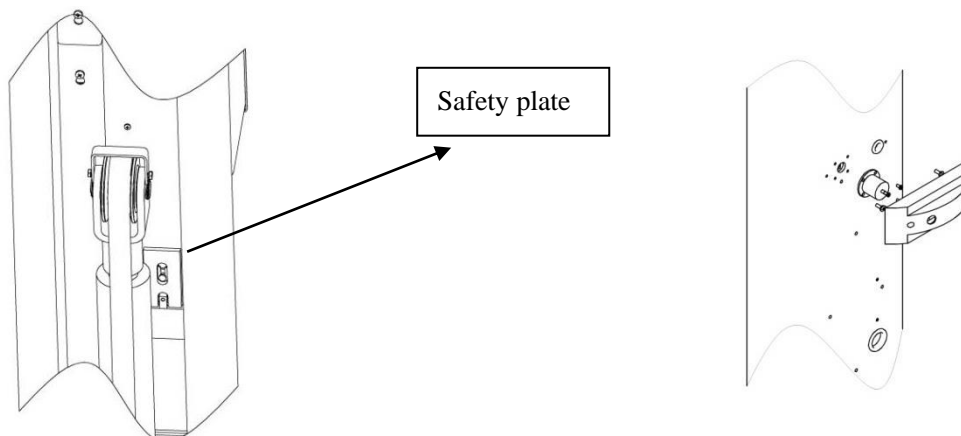

Step ten: mount the power unit and the control box

1. Mount the power unit on the main post
2. Connect the power unit with the control box as the wiring diagram

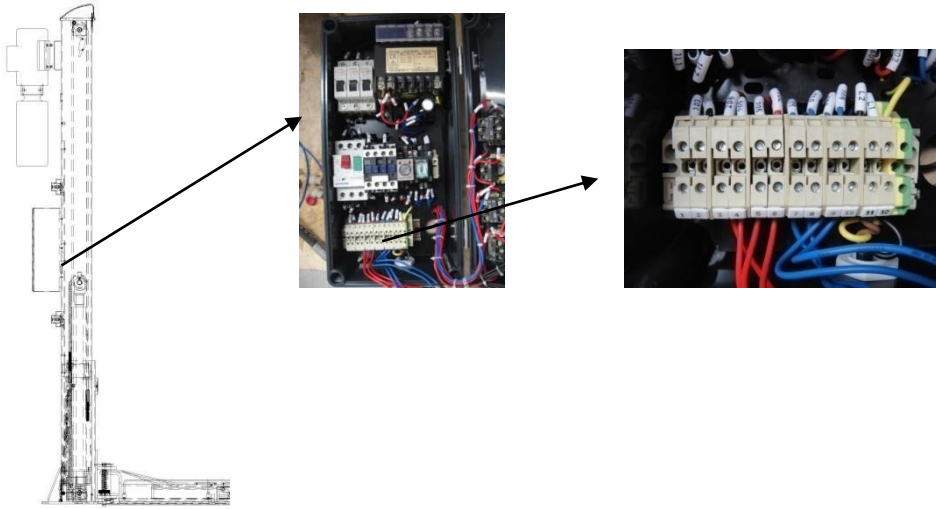

3. Connect the limit switch

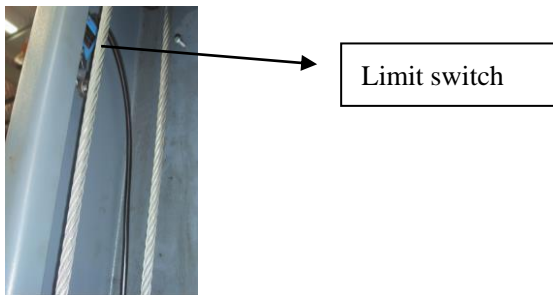

Step eleven: Install the oil hose cover

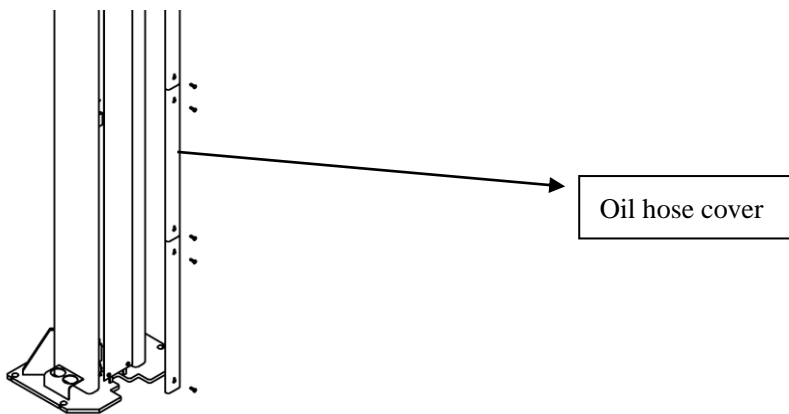

Step twelve: Install the lifting arms

Connect the lifting arm and the carriage by pin. Install the swing arms on the carriages. Check to make sure the rack on the lock should be fully engaged.

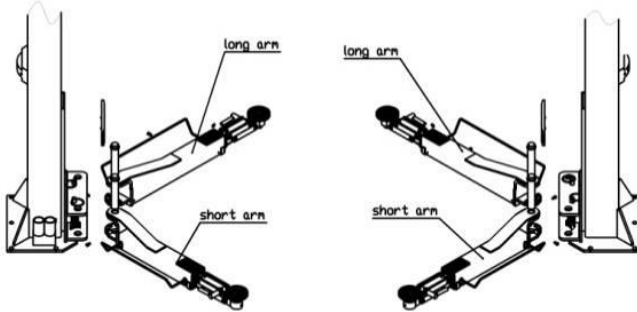

Step thirteen: fill the hydraulic oil

The volume of the oil tank is 10L, To insure the lift in a normal work condition, the oil should be over 80% of the oil tank volume; Use AW 32# in winter/46# in summer or other good quality garage hydraulic oil.

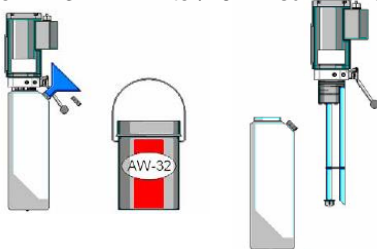

Step fourteen: try running the lift

Do not place any vehicle in this step

Step fifteen: install the chain protection and the door-opening protection

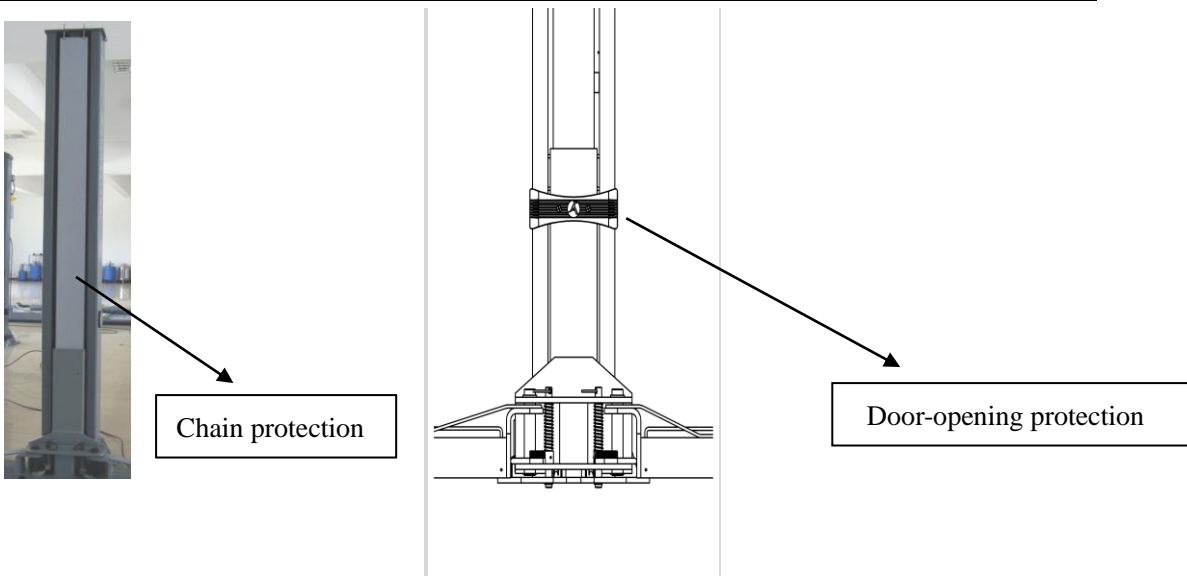

Step sixteen: install the cover plate

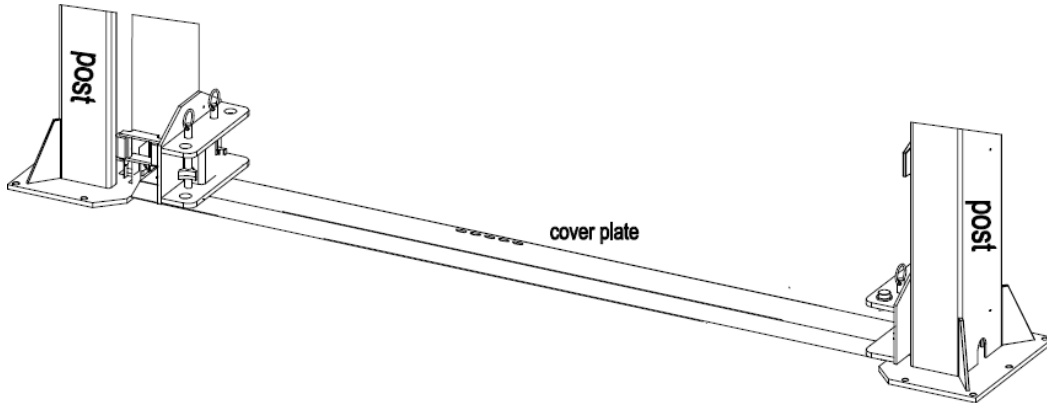

3.4 Check list after installation

S/N	Check items	YES	NO
1	If the columns is vertical to the floor		
2	If the two posts are horizontal		
3	If the oil hose connection is correct		
4	If the wire rope connection is correct		
5	If the arm is fastening		
6	If the wiring is correct		
7	If the other joints are tightened		

4. Operation instruction

4.1 Precautions during operation

Remark: Only authorized staff can adjust the system pressure on the power unit.

4.1.1 Check all the pipelines and joints before use. The machine only can be used after there is not any leakage.

4.1.2 The lift, if its safety device malfunctions, shall not be used.

4.1.3 The machine shall not lift or lower an automobile if the center of gravity of automobile is not within the supporting range of the supporting device. Otherwise, the manufacturer will not bear any responsibility for the consequence resulted from the operation above mentioned.

4.1.4 The staff or operators shall be in a safe position when the machine lift or lower.

4.1.5 When the lift with vehicle on reaches a desired height, first of all, the main switch must be turned off before the automobile is repaired so as to prevent non-operator or unauthorized person from pressing the start switch.

4.1.6. Always lock the lift by pressing handle on power unit before going under the vehicle. Never allow anyone to go under the lift when raising or lowering.

4.2 control box panel description

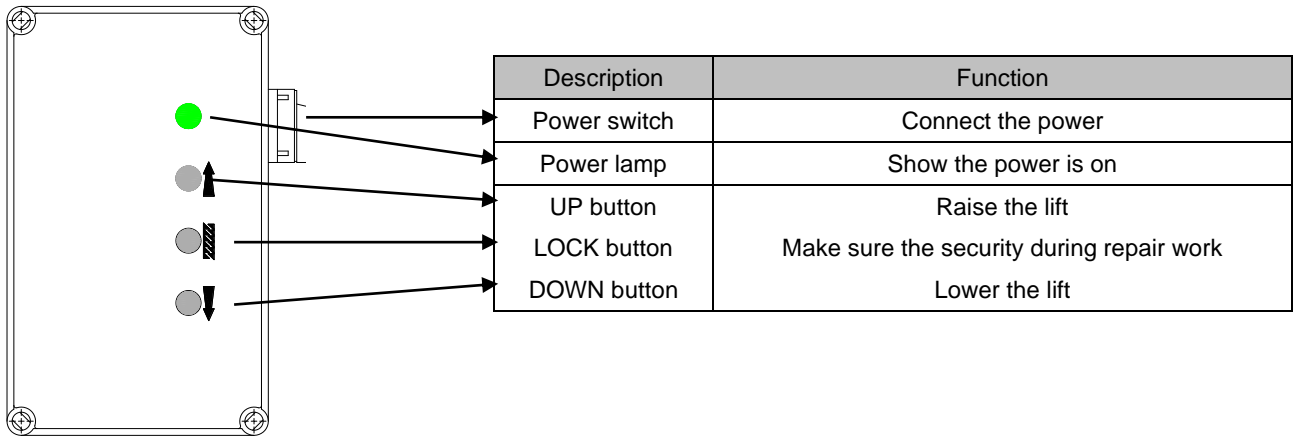

4.3 Flow chart for operation

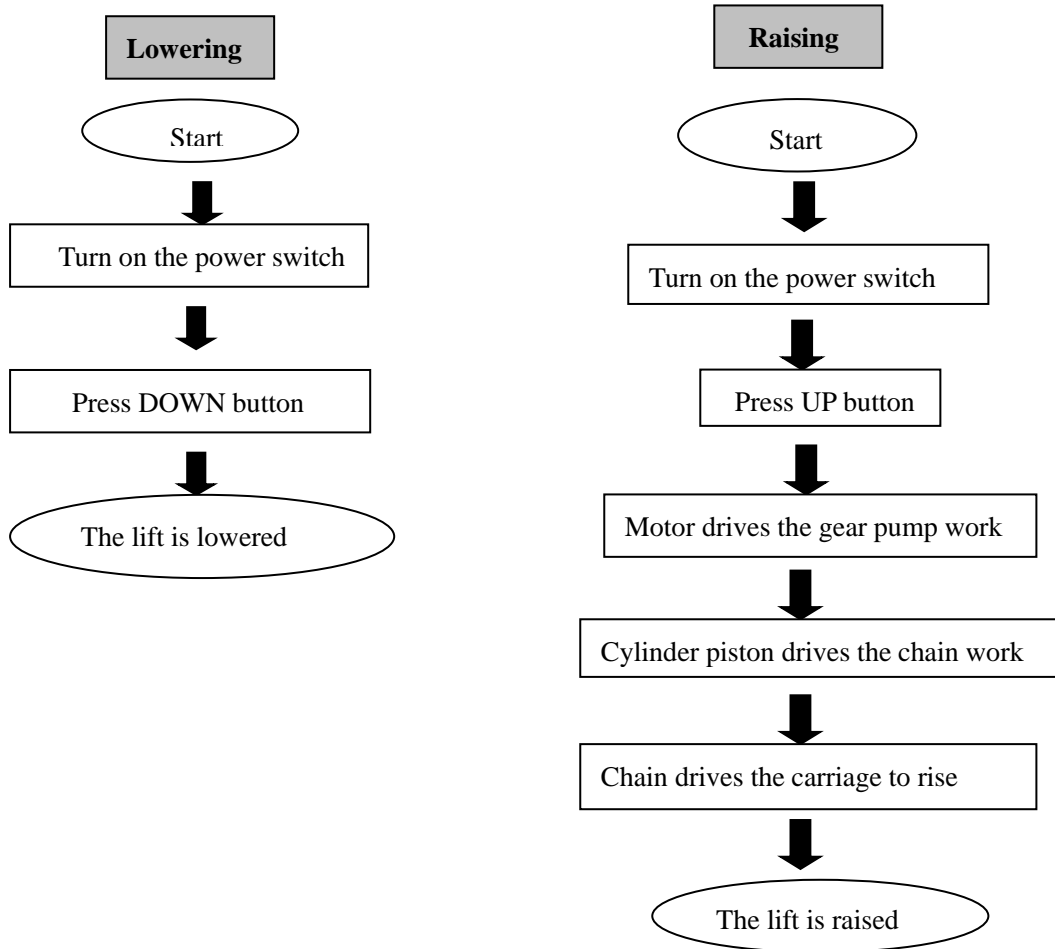

4.4 Operation

Raise the lift

1. Make sure that you have read the operation manual before operation.
2. Position the vehicle between columns.
3. Adjust the swing lift arms so that the vehicle is positioned with the center of gravity of midway between pads
4. Turn on the Power Switch, the power indicating light is on, raise the lift by pressing the up button on control box until the pads touch firmly the right points and recheck if the vehicle is secure.
5. Continue to press the UP button to raise the lift to the demanded height.
6. Press the handle of the manual unloading valve to lock the lift
7. Check the security of vehicle, and then turn off the power switch before performing maintenance or repair work.

Lower the lift

1. Turn on the power switch
2. Press the DOWN button on control box, the lift will raise about 5CM automatically to release the safety lock and then, the lift lowers.
3. Before driving away the vehicle, clear all the obstacles.

5. Trouble Shooting

ATTENTION: If you could not do the trouble shooting by your own, please contact us for help. You are requested to send us the serial No. with detailed description of faulty machine or parts. We keep the right to ask for photos and pictures for diagnostics

TROUBLE	CAUSE	SOLUTION
Abnormal noise	There is abrasion in the post	Grease the inside of the post
	There is trash in the post	Clear away the trash
Motor does not run and will not rise	The wire connection is loose	Check it and make a good connection.
	The motor is blown	Replace it.
	The limit switch is damaged or the wire connection is loose	Make a good connection, adjust or replace the limit switch.
Motor runs but will not raise	The motor reverse	Check the wire connection.
	A piece of trash is under overflow valve or the overflow valve is loose	Clean or adjusts the it
	The gear pump is damaged	Replace it
	Oil level too low	Oil level should be more than 2/3 oil tank volume.
	The oil absorbing pipe is loose	Tighten it
	A piece of trash is under cushion valve or the cushion valve is loose	Clean or adjusts it
Carriages go down slowly after raising Raising too slow	The oil hose leaks	Check or replace it
	The seal of the cylinder is abrasion	Replace the seal
	The single valve leaks	Clean or replace it
	The overflow valve leaks	Clean or replace it
	Manual unloading valve or electrical unloading valve leaks	Clean or replace it.
	The oil filter is jammed	Clean or replace it.
Lowering too slow	Oil level too low.	Oil level should be more than 2/3 oil tank volume.
	The overflow valve is loose	Adjust it.
	The hydraulic oil is too hot (above 45°)	Change the oil
	The seal of the cylinder is abrasion	Replace the seal.
	The post inside is rough	Grease the post inside
	There is trash in the throttle valve	Clean or replace
The wire rope is abraded	The hydraulic oil is dirty	Change the oil
	There is trash in the anti-surge valve	Replace it
	There is trash in the oil hose	Replace it
	Did not grease the wire rope with grease in installation or the use time of the wire rope is out of its service lifetime	Replace it

6. Maintenance

The several pieces of maintenance operations to be carried out are described below. A low operating cost and a long life of the machine are from routine observation of there operations.

The listed intervention times are given for information and they refer to normal operating conditions. They can change according to the kind of service, environment, frequency of use, etc.

THE FOLLOW PARTS ARE NEEDED TO BE LUBRICATED

S/N	Description
1	Upper wheel
2	Wire rope
3	Chain wheel
4	Chain
5	Sliding block
6	Pin
7	Arm block
8	Lifting arm
9	Tray
10	Down wheel

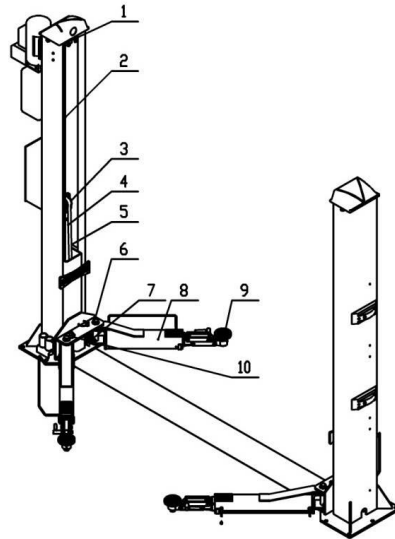

6.1. DAILY PRE-OPERATION CHECK

The user should perform daily check. Daily check of safety latch system is very important – the discovery of device failure before needed could save you from expensive property damage, lost production time, serious personal injury, even death.

- Check safety lock audibly and visually while in operation.
- Check safety latch for free movement and full engagement with rack.
- Check hydraulic connections and hoses for leakage.
- Check chain connections for bends, cracks and looseness.
- Check cables connections for bends, cracks and looseness.
- Check for frayed cables in both raised and lowered position.
- Check snap rings at each roller and sheave.
- Check bolts, nut and screws. Tighten if needed.
- Check wiring and switches for damage.
- Keep base plate free of dirt, grease or any other corrosive substances.
- Check floor for stress cracks near anchor bolts.

6.2. WEEKLY MAINTENANCE

- Check the cleanness of the mobile parts.
- Check the safety device as previously described.
- Check hydraulic fluid level as follow: let the trolleys go up completely and in case they do not reach maximum height, add oil.
- Check and tighten bolts, nuts and screws

6.3. MONTHLY MAINTENANCE

- Check the tightening of screws
- Check the hydraulic system seal and tighten the loose unions, if necessary.
- Check the greasing and wear condition of pins, rollers, bushes, of trolley structure as well as arms and relevant extensions, if necessary, replace the damaged parts by original spare parts.

6.4. YEARLY MAINTENANCE

- Lubricate chain.
- Grease rub blocks and column surface contacting rub blocks.
- Change the hydraulic fluid. Good maintenance procedure makes it mandatory to keep hydraulic fluid clean. Due to operating temperature, type of service, contamination levels, filtration and chemical composition of fluid, the hydraulic fluid may need to be changed more or less frequently.

If the above maintenance operations are carried out, there will be an advantage for the user, who will find the equipment in perfect condition each time he restarts work.

7. ANNEX

ANNEX1, Shipping Sheet

S/N	DESCRIPTION	PART NO	MATERIAL	Q'TY
1	Main and assistant post	JA3500T-A1	Component	2
2	Carriage	JA3500T -A2	Component	2
6	Power unit	JA3500T -B5-B6	Component	1
7	Assistant cylinder	JA3500T -A5-B4	Component	1
8	Main cylinder	JA3500T -A5-B5	Component	1
9	Electrical system	JA3500T -A5	Component	1
		Control box		1
		Electromagnet and its cover		1
10	Wire rope L=8785mm	JA3500T -A6	Component	2
11	Long arm	JA3500T -A7	Component	2
12	Short arm	JA3500T -A8	Component	2
13	Bottom trough plate	JA3500T -A9	Welding piece	1
14	Cover plate	JA3500T -A10	Q235A	1
15	Right packing frame	JA3500T -A30-B1		
	Topper plate cover	JA3500T -A16	ABS	2

Jema Autolifte – Denmark - WE ARE HERE TO SURPRISE!

16	Left packing frame	JA3500T -A30-B2		
20	Carton(include the following parts)			
22	Pin	A12	Component	4
24	Foot protector	A9-B3	Welding piece	2
25	Foot protector	JA3500T -A7-B5	Component	2
26	Tray	JA3500T -A7-B4	Component	4
27	Pulling rod	JA3500T -A2-B1	Component	4
28	Oil hose L=2550mm	JA3500T -B4-B1	Component	1
29	Oil hose L=2880mm	JA3500T -B4-B2	Component	1
30	Safety plate	JA3500T -A13	45	4
32	Electromagnet cover	JA3500T -A15	ABS	4
34	Positioning block	JA3500T E-A17	Q235A	4
35	Oil hose cover	JA3500T -A18	Q235A	6
36	Chain protection	JA3500T -A1-B5		2
37	Chain protection hook	JA3500T -A1-B6	Welding piece	4
38	Door-opening protection	JA3500T -A7-B10	Rubber	2
39	Bolt	M8*30	Standard piece	4
41	Screw	M8*12	Standard piece	8
42	Screw	M5*10	Standard piece	24
43	Screw	M5*20	Standard piece	12
44	Screw	M6*8	Standard piece	4
45	Screw	M6*16	Standard piece	4
46	Screw	M8*25	Standard piece	4
47	Flat washer	6	Standard piece	8
48	Flat washer	10	Standard piece	4
49	Spring washer	10	Standard piece	4
50	Nut	M6	Standard piece	8
51	Nut	M0	Standard piece	4
52	Circlip for shaft	50	Standard piece	4
53	Expansion bolt	M16*160	Standard piece	10

ANNEX 2, Overall Diagram

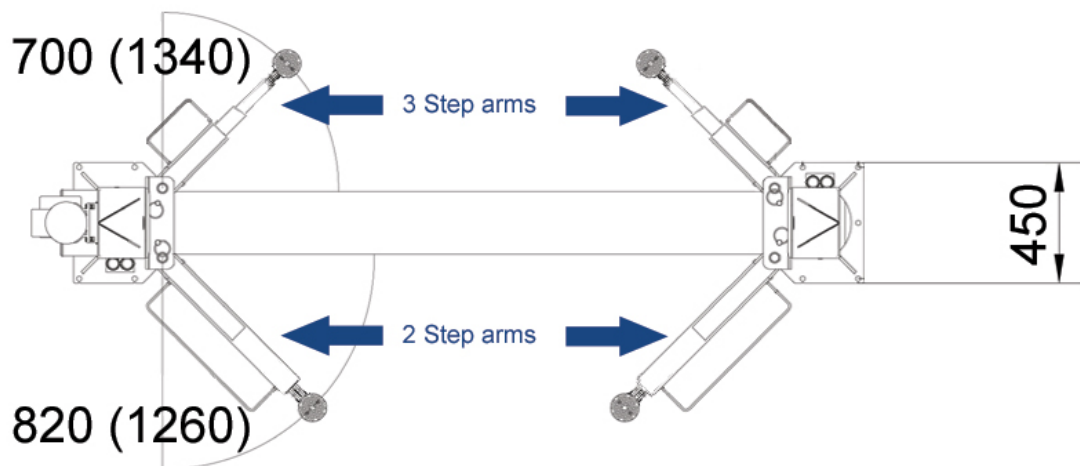
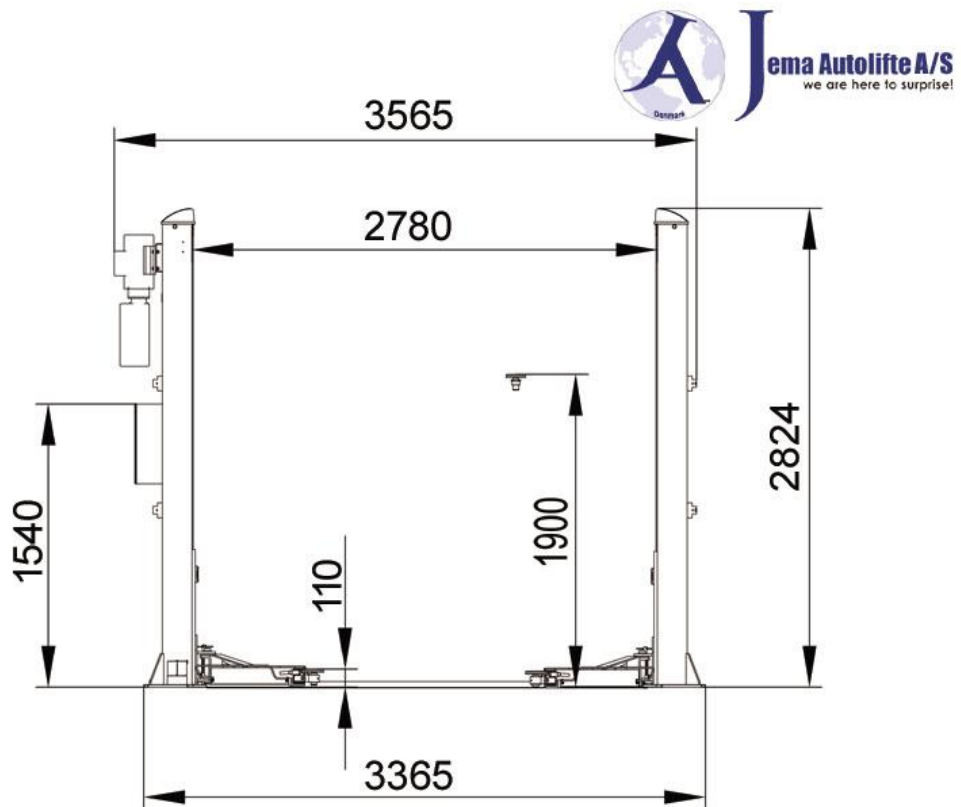

ANNEX3, Space Required

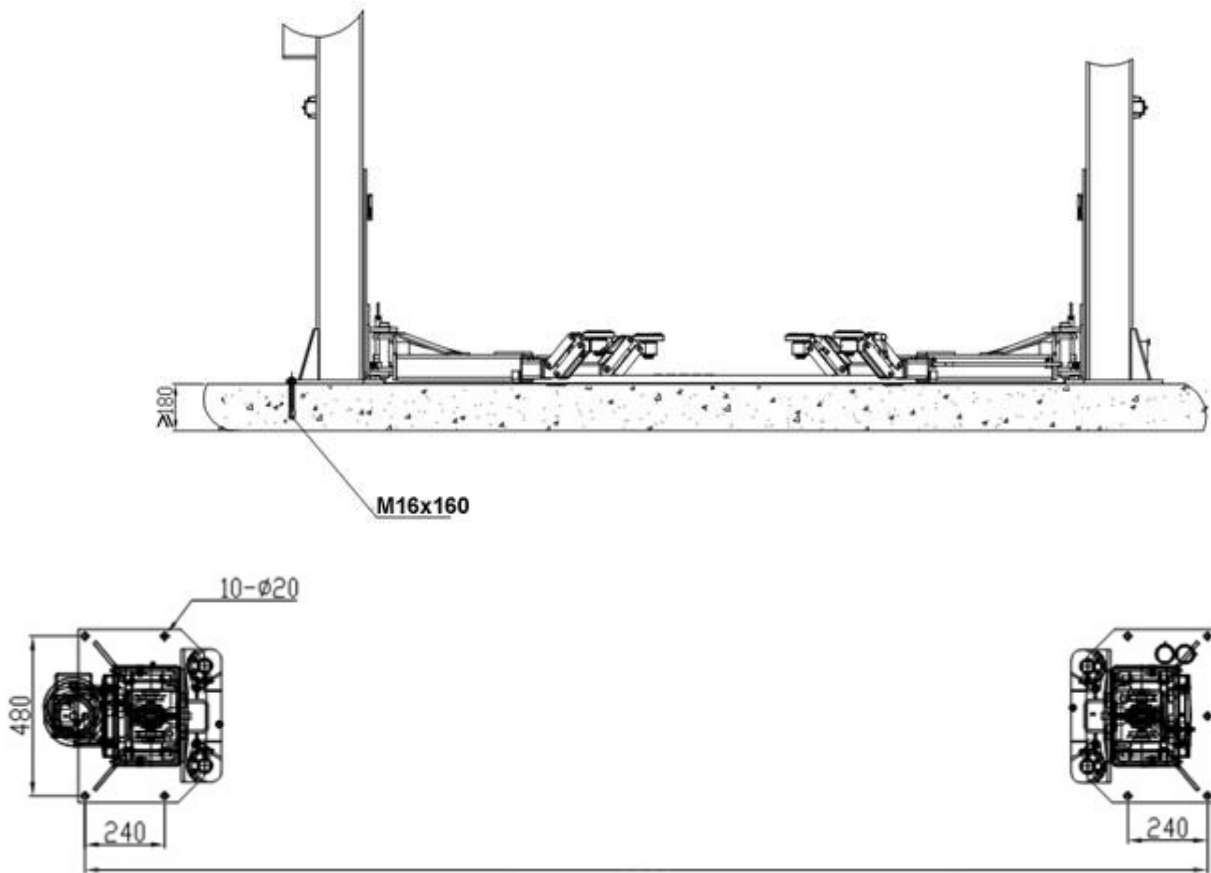

ANNEX4, Hydraulic Connection

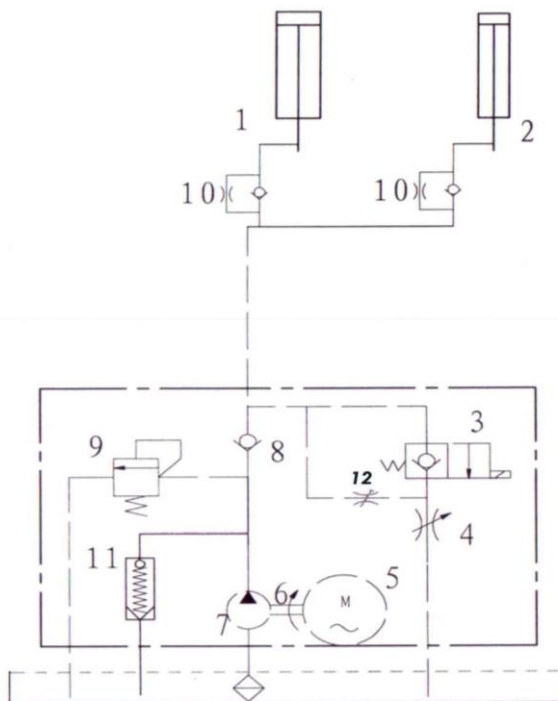

1. main cylinder
2. assistant cylinder
3. electrical unloading valve
4. throttle valve
5. motor
6. coupling
7. gear pump
8. single-way valve
9. overflow valve
10. anti-surge valve
11. cushion valve

Annex5, Wiring diagram Single phase

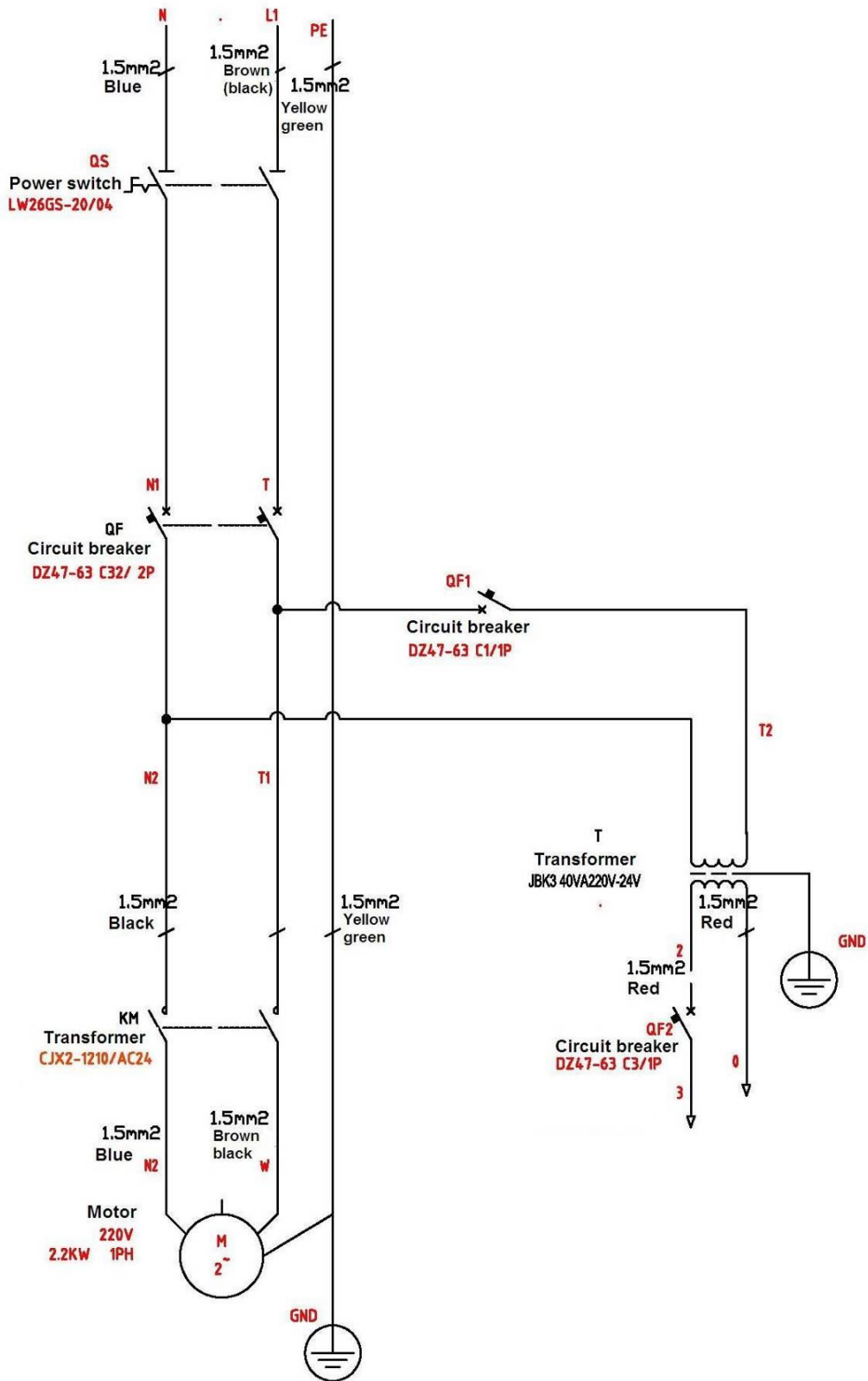

Jema Autolifte – Denmark - WE ARE HERE TO SURPRISE!

S/N	PART NO	DESCRIPTION	SPEC	Q'TY	REMARK
1	VD	RECTIFIER	KBPC5A-35A	1	
2	YV	ELECTROVALVE	DC24V	1	
3	YA	ELECTROMAGNET	MQZ2-10/DC24	4	
4	C	CAPACITOR	4700UF-50V	1	
5	JBK	TRANSFORMER	JBK3-100VA	1	
6	HL	POWER LAMP	AD17	1	
7	SQ1	LIMIT SWITCH	8104	1	
8	KM	AC CONTACTOR	CJX2-1210/AC24	1	
9	HK	POWER SWITCH	LW26GS-20/04	1	
10	FU2	FUSE	5A	1	
11	FU1	FUSE	16A/32A	3/2	
12	FU	FUSE	10A	1	
13	M	MOTOR	380V 220V 2.2KW	1	
14	SB3	BUTTON	Y090	1	DOWN
15	SB2	BUTTON	Y090	1	LOCK
16	SB1	BUTTON	Y090	1	UP
18	KT	TIME RELAY	ST6PA-5S/AC24	1	
19	SB4	EMG. STOP	Y090	1	

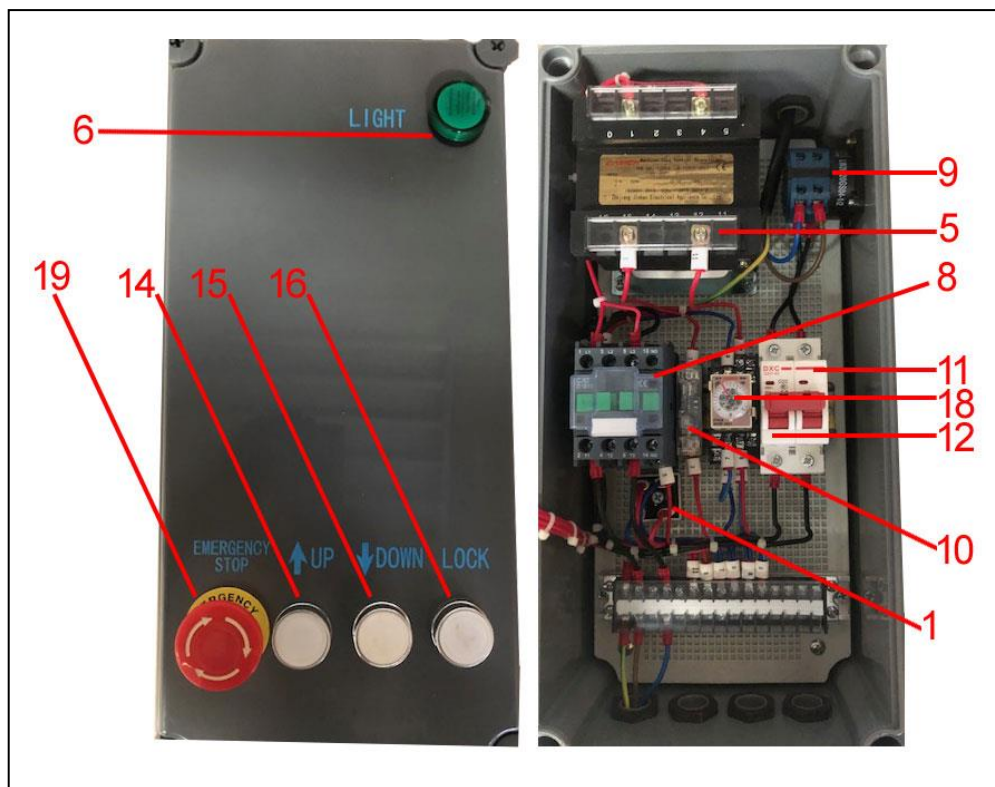

ANNEX6, Parts list of power unit

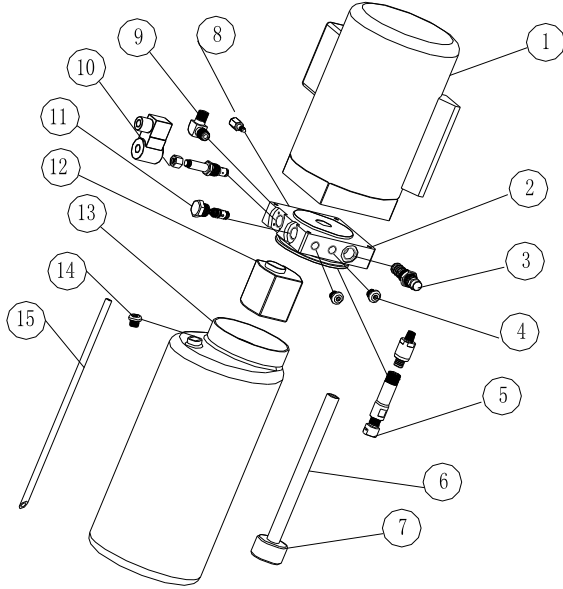

S/N	DESCRIPTION	Q'TY
1	MOTOR	1
2	VALVE BOARD	1
3	OVERFLOW VALVE	1
4	FITTING	2
5	CUSHION VALVE	1
6	ABSORBING OIL PIPE	1
7	OIL FILTER	1
8	THROTTLE VALVE	1
9	OIL HOSE TIE-IN	1
10	ECTRP,AGMETOC UNLOADING VALVE	1
11	SINGLE-WAY VALVE	1
12	GEAR PUMP	1
13	OIL TANK	1
14	OIL TANK COVER	1
15	OIL BACK PIPE	1

Parts List

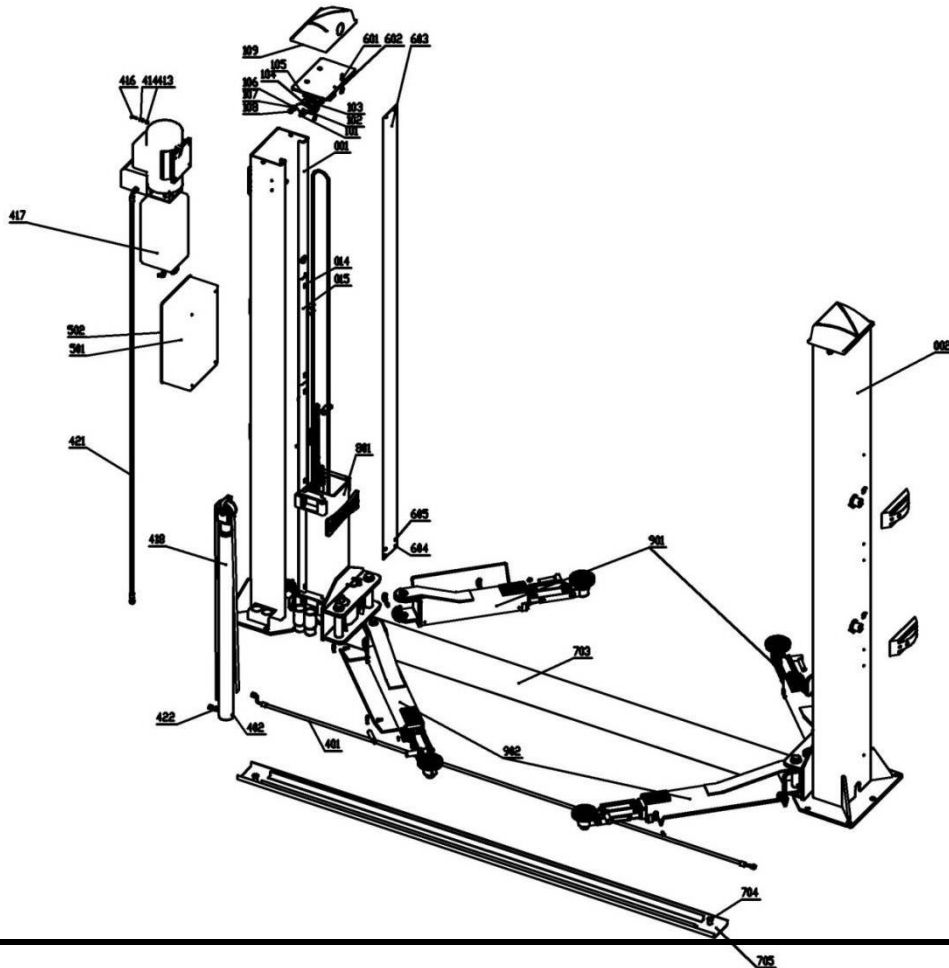

Jema Autolifte – Denmark - WE ARE HERE TO SURPRISE!

S/N	DRAWING#	DESCRIPTION	Q'TY	MATERIAL	REMARK
001	JA3500T-A1	Main post	1	Welding piece	
002	JA3500T -A2	Assistant post			
007	SF-1	Oil less bearing 2512	4	Standard piece	
008	JA3500T -A1-B2	Spacer	4	Q235A	
009	GB/T894.1-1986	Circlip for shaft 25	2	Standard piece	
012	JA3500T -A1-B1	Down wheel	1	45#	
013	JA3500T -A11	Height adapter	4	Welding piece	130MM
014	GB/818-2000	Screw M6*20	12	Standard piece	
015	JA3500T -A18	Oil hose cover	6	Q235A	
016	JA3500T -A13	Safety plate	4	45#	
017	JA3500T -A17	Positioning block	4	Q235A	
018	GB/818-2000	Screw M6*16	4	Standard piece	
019	GB/818-2000	Screw M5*10	16	Standard piece	
020	JA3500T -A14	Electromagnet	4	Component	
021	JA3500T -A15	Electromagnet cover	4	Plastic	
022	GB/818-2000.	Screw M6*16	8	Standard piece	
101		Screw M5*10	2	Standard piece	
102	JA3500T -A3-B3	Screen	2	Q235A	
103	JA3500T -A3-B1	Up wheel	2	45#	
104	SF-1	Oil less bearing 2518	2	Standard piece	
105	JA3500T -A3-B1	Topper plate	2	Welding piece	
106	GB/T93-2000	Flat washer 12	4	Standard piece	
107	GB/T93-2000	Spring washer 12	4	Standard piece	
108	GB/T5781-2000	Bolt M12*25	4	Standard piece	
109	JA3500T -A16	Topper plate cover	2	Plastic	
801	JA3500T -A2-B2	Carriage	2	Welding piece	
814	JA3500T -A2-B1	Pulling rod	4	Welding piece	
815	JA6214F-A3-B5	Compression spring	4	Standard piece	
816	JA6214F-A3-B3	Teeth block	4	Q235A	
817		Circlip for shaft 22	4	Standard piece	
818	5*35	Spring pin	4	Standard piece	
222	M8*16	Screw	4	Standard piece	
223	JA3500T -A7-B10	Door-opening protection	2	Rubber	
224	JA3500T -A7-B1	Sliding block	16	Nylon 1010	
225	JA3500T -A6	Wire rope release	2	Component	L=8785mm
901	JA3500T -A8	Short arm	1	Component	
902	JA3500T -A7	Long arm	2	Component	
903	JA3500T -A12	Pin	4	Component	
904	JA3500T -A8-B5	Foot protector	2	Welding piece	
905	JA3500T -A7-B3	Long extensive arm	2	Welding piece	

Jema Autolifte – Denmark - WE ARE HERE TO SURPRISE!

906	JA3500T -A7-B1	Long arm	2	Welding piece	
907	JA3500T -A8-B1	Short arm	2	Welding piece	
908	M5*12	Screw	16	Standard piece	
909	JA3500T -A7-B2	Rubber pad	4	Rubber	
910		Circlip for shaft 26	4	Standard piece	
911	JA3500T -A7-B4-C4	Round rubber pad	4	Rubber	
912	JA3500T -A7-B4-C1	Tray	4	Welding piece	
917	JA3500T -A8-B2	Short extensive arm	2	Welding piece	
918	A9-B3	Foot protector	2	Welding piece	
919	M8*16	Screw	8	Standard piece	
920	M10*16	Screw	12	Standard piece	
921	A4-B3	Teeth block	4	Q235A	
401	A4-B2	Oil hose	1	Component	2880mm
402	JA3500T -A5-B10	Short tie-in	1	35#	With anti-surge valve
403	JA3500T -A5-B-4	Assistant cylinder	1	Component	
404	LH1234-127	Leaf chain	2	Component	
405	JA3500T -A5-B1	Chain wheel seat	2	Welding piece	
406	GB/T894.2-1986	Circlip for shaft 25	4	Standard piece	
407	JA3500T -A5-B2	Chain wheel shaft	2	45#	
408	SF-1	Oil less bearing 2548	2	Standard piece	
409	JA3500T -A5-B3	Chain wheel	2	45#	
410	JA3500T -A5-B11	Screen plate	2	Q235A	
411		Spring washer M6	4	Standard piece	
412		Screw M6*20	4	Standard piece	
413	M10	Nut	4	Standard piece	
414	M10	Flat washer	4	Standard piece	
415	M10	Spring washer	4	Standard piece	
416	M10*30	Bolt	4	Standard piece	
417	JA3500T -A5-B6	Power unit	1	Component	
420	JA3500T -A5-B5	Main cylinder	1	Component	
421	JA3500T -A4-B1	Main oil hose	1	Component	2555mm
422	JA6214-A5-B4	Long tie-in	1	Component	With anti-surge valve
501	JA3500T -A4	Electrical system	1	Component	
502	GB/T70.8-1885	Screw M5*12	4	Standard piece	
601		Nut M6	8	Standard piece	
602	JA3500T -A1-B6	Chain protection hook	4	Welding piece	
603	JA3500T -A1-B5	Chain protection	2	Q235A	L=2700mm
604		Flat washer M6	8	Standard piece	
605	M6*8	Screw	4	Standard piece	
703	JA3500T -A10	Cover plate	1	Q235A	
704	GB/T70.3-2000	Screw M12*16	2	Standard piece	

Jema Autolifte – Denmark - WE ARE HERE TO SURPRISE!

705	JA3500T -A9	Bottom trough plate	1	Welding piece
-----	-------------	---------------------	---	---------------

Annex 7. Spare parts list

Spare parts list---electrical system

S/N	Material No.	Description	Spec.	Unit	Q'ty	Remark
1	321001	Power switch	LW26GS-20/04	Pcs	1	
2	328064	Button	Y090	Pcs	3	
3	328003	Power lamp	AD17-22G-AC24	Pcs	1	
4	320009	Transformer	JBK-100VA220V-24V	Pcs	1	The outlook is the same as item 5
5		Transformer	JBK-100VA230V-24V	Pcs	1	The outlook is the same as item 5
6		Transformer	JBK-100VA240V-24V	Pcs	1	The outlook is the same as item 5
7	320019	Transformer	JBK-100VA380V-24V	Pcs	1	
8		Transformer	JBK-100VA400V-24V	Pcs	1	The outlook is the same as item 5
9		Transformer	JBK-100VA415V-24V	Pcs	1	The outlook is the same as item 5
10	328005	AC contactor	CJX2-1210/AC24	Pcs	1	

Jema Autolifte – Denmark - WE ARE HERE TO SURPRISE!

11	540035	Fuse holder	TFBR-102	Pcs	1	
12	328008	Fuse holder	RT18-32X	Pcs	3	
13	328010	Fuse	16A (10*38)	Pcs	6	
14	32801	Fuse	32A (10*38)	Pcs	6	
15	328011	Fuse	5A (6*30)	Pcs	2	
16	540088	Fuse	10A (6*30)	Pcs	2	
17	321024	Limit switch	ME8104	Pcs	1	
18	323002	Terminal block	TB1512L	Pcs	1	
19	328026	Rectifier	KBPC5A-35A	Pcs	1	

Jema Autolifte – Denmark - WE ARE HERE TO SURPRISE!

20	328014	Capacitor	4700UF/50V	Pcs	1	
21	328074	Control box		Pcs	1	
22	328019	Time relay	ST6PA-5S/AC24V	Pcs	1	
23	328020	Time relay seat	PYF-08A	Pcs	1	

Spare parts list---machine part

S/N	DRAWING#	DESCRIPTION	Q'TY	MATERIAL	REMARK
012	JA3500T-C-A1-B1	Down wheel	1	45#	
013	JA3500T-C -A11	Height adapter	4	Welding piece	130MM
016	JA3500T-C -A13	Safety plate	4	45#	
017	JA3500T-C -A17	Positioning block	4	Q235A	
020	JA3500T-C -A14	Electromagnet	4	Component	
103	JA3500T-C -A3-B1	Up wheel	2	45#	
815	JA6214F-A3-B5	Spring	4	Standard piece	
816	JA6214F-A3-B3	Teeth block	4	Q235A	
223	JA3500T-C -A7-B10	Door-opening protection	2	Rubber	
224	JA3500T-C -A7-B1	Sliding block	16	Nylon 1010	
909	JA3500T-C -A7-B2	Rubber pad	4	Rubber	
911	JA3500T-C -A7-B4-C4	Rubber pad	4	Rubber	
921	JA3214F-A4-B3	Teeth block	4	Q235A	
401	JA3500T-C -A4-B2	Oil hose	1	Component	2880mm
402	JA3500T-C -A5-B10	Short tie-in	1	35#	With anti-surge valve
403	JA3500T-C -A5-B-4	Assistant cylinder	1	Component	
409	JA3500T-C -A5-B3	Chain wheel	2	45#	
417	JA3500T-C -A5-B6	Power unit	1	Component	
420	JA3500T-C -A5-B5	Main cylinder	1	Component	
421	JA3500T-C -A4-B1	Main oil hose	1	Component	2555mm
422	JA6214-A5-B4	Long tie-in	1	Component	With anti-surge valve
603	JA3500T-C -A1-B5	Chain protection	2	Q235A	2700

Annex8, Size and weight requirement for the vehicle

Model No.	A (mm)	B (mm)	C (mm)	D (T)	E (T)	F (T)	G (T)
JA3500T	2400	2900	100	2.0	1.5	1.5	2.0

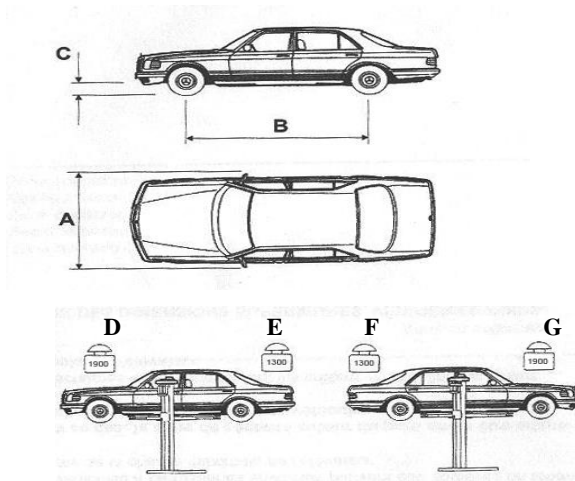

Valve board diagram

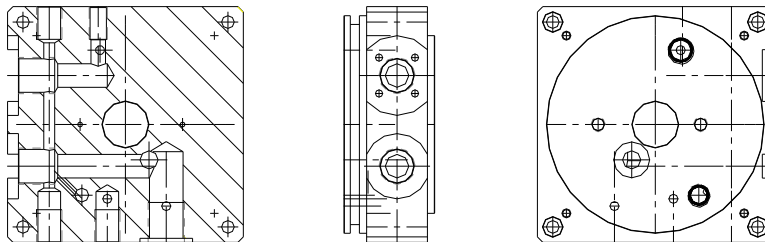

Jema Autolifte

Tel/fax +45 48180300/ +45 48195240

E-mail: info@jemaautolifte.dk

www.jemaautolifte.dk



No. 6038



EC Type-Examination Certificate

For the requirements of the Machinery Directive 2006/42/EC
For Annex IV machinery

Certificate No.: CE-C-1206-16-214-02-5A
Date of Issue: 2017.02.15
Date of Expiry: 2022.02.14

NAME AND ADDRESS OF THE MANUFACTURER: QiDong New Power Electromechanical Manufacturing Co., Ltd
Xiang yang Industrial Area, QiDong, Jiangsu, Province P. R. China

PRODUCT DESCRIPTION TYPE AND MODEL: DW-4 005K, capacity 4000kg, two post vehicle lift with bottom bar, manual safety catch

APPLICABLE STANDARDS: EN ISO 12100:2010 Safety of machinery - General principles for design - Risk assessment and risk reduction
EN 1493:2010 Vehicle Lift
EN 60204-1:2006+A1:2009 Safety of machinery - Electrical equipment of machines - Part 1 - General requirements

TECHNICAL FILE REF. NO.: TF-C-1206-16-214-02-5A

A COPY IS AVAILABLE FROM: CCQS UK Ltd., Level 7, Westgate House, Westgate Road, London W5 1YY UK

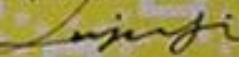

The technical file, accompanying documentation and the equipment which they describe have been found to be in compliance with the requirements of the Machinery Directive 2006/42/EC.
The responsible person defined above has responsibility for ensuring that all future serial manufacture of the machinery conforms to the sample submitted for EC type-examination referenced above.
Any changes to the design of the machinery certified here must be advised to CCQS UK Ltd. for re-assessment.
A CE marking should not be fixed to the equipment until the requirements of all relevant directives have been met.

Approved by: JY. Liu - Managing Director  **Date:** 2017-02-15

Appointed by UK Government
as a Notified Body
for CE Marking No. 1105

CCQS UK Ltd.
Level 7, Westgate House, Westgate
Road, London W5 1YY UK
Tel: +44 (0) 20 8991 3455
Email: info@ccqs.co.uk
If in any doubt about the integrity of this certificate,
please verify it on our website at
<http://www.ccqs.co.uk>





EC Type-Examination Certificate

For the requirements of the Machinery Directive 2006/42/EC
For Annex IV machinery

Certificate No.: CE-C-1205-16-214-01-5A
Date of issue: 2017.02.15
Date of expiry: 2022.02.14

NAME AND ADDRESS OF THE MANUFACTURER:	QiDong New Power Electromechanical Manufacturing Co., Ltd Xiang yang Industrial Area, Qidong, Jiangsu, Province P. R. China
PRODUCT DESCRIPTION/TYPE AND MODEL:	DWV-4.0LEX, capacity 4000kg, two post vehicle lift with top bar, solenoid safety catch
APPLICABLE STANDARDS:	EN ISO 12100:2010 Safety of machinery – General principles for design - Risk assessment and risk reduction EN 1493:2010 Vehicle Lift EN 60204-1:2006+A1:2009 Safety of machinery - Electrical equipment of machines - Part 1: General requirements
TECHNICAL FILE REF. NO.:	TF-C-1205-16-214-01-5A
A COPY IS AVAILABLE FROM:	CCQS UK Ltd., Level 7, Westgate House, Westgate Road, London W5 1YY UK

The technical file, accompanying documentation and the equipment which they describe have been found to be in compliance with the requirements of the Machinery Directive 2006/42/EC.
The responsible person defined above has responsibility for ensuring that all future serial manufactures of the machinery conforms to the sample submitted for EC type-examination referenced above.
Any changes to the design of the machinery certified here must be advised to CCQS UK Ltd. for re-assessment.
A CE marking should not be fixed to the equipment until the requirements of all relevant directives have been met.

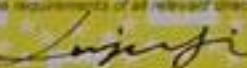
Approved by: JY. Liu - Managing Director  **Date:** 2017-02-15

Appointed by UK Government
as a Notified Body
for CE Marking No. 1105

CCQS UK Ltd.
Level 7, Westgate House, Westgate
Road, London W5 1YY UK
Tel: +44 (0) 20 8991 3488
Email: info@ccqs.co.uk
If in any doubt about the integrity of this certificate
please verify it on our website at
<http://www.ccqs.co.uk>

